

# SVO



## CONTROL AND VISUALIZATION OF VOLTAGE, PHASE AND FREQUENCY IN THREE-PHASE LINES WITHOUT NEUTRAL

| Function                        | Voltage relay for three-phase lines without neutral.<br>Control of an auxiliary voltage or of its own supply voltage.  |   |  |  |      |  |      |       |          |        |  |        |          |        |  |        |          |        |  |        |     |        |  |     |     |     |  |     |     |     |  |
|---------------------------------|--|---|--|--|------|--|------|-------|----------|--------|--|--------|----------|--------|--|--------|----------|--------|--|--------|-----|--------|--|-----|-----|-----|--|-----|-----|-----|--|
| Operating mode                  | Configurable by the user. Each one of the available relays it is assigned with its own operating mode for one or more magnitudes, reacting by the first one which is produced.   |   |  |  |      |  |      |       |          |        |  |        |          |        |  |        |          |        |  |        |     |        |  |     |     |     |  |     |     |     |  |
| Voltage control                 | <ul style="list-style-type: none"> <li>· Operating margin: <math>\pm 18\%</math> of the nominal voltage.</li> <li>· Operativity by maximum and/or minimum voltage between phases. Independent adjustment L1-L2, L1-L3 and L2-L3. At each case, adjustment for detection and/or for release.</li> <li>· Reading value RMS</li> </ul>  |   |  |  |      |  |      |       |          |        |  |        |          |        |  |        |          |        |  |        |     |        |  |     |     |     |  |     |     |     |  |
| Phase sequence control          | It is detected that the phases come in the correct order.  |   |  |  |      |  |      |       |          |        |  |        |          |        |  |        |          |        |  |        |     |        |  |     |     |     |  |     |     |     |  |
| Control of the phases unbalance | <ul style="list-style-type: none"> <li>· Adjustable from 0 and 100%.</li> <li>· Only one adjustment for the three phases.</li> </ul>   |   |  |  |      |  |      |       |          |        |  |        |          |        |  |        |          |        |  |        |     |        |  |     |     |     |  |     |     |     |  |
| Frequency control               | <ul style="list-style-type: none"> <li>· Adjustable from 43..70 Hz.</li> <li>· Operativity by maximum and/or minimum frequency. At each case, adjustment for detection and/or for release.</li> <li>· If the frequency changes in such a value that the relay loose the required precision for a normal operating mode, it switches to the alarm mode (See page 4 for detailed information).</li> </ul>  |   |  |  |      |  |      |       |          |        |  |        |          |        |  |        |          |        |  |        |     |        |  |     |     |     |  |     |     |     |  |
| Timing                          | <ul style="list-style-type: none"> <li>· Associable to the detection and/or to the release of whichever relay.</li> <li>· Adjustable from 0,01s..999,9h</li> <li>· Repeating precision <math>\pm 30</math> ppm</li> </ul>  |   |  |  |      |  |      |       |          |        |  |        |          |        |  |        |          |        |  |        |     |        |  |     |     |     |  |     |     |     |  |
| Voltage precision               | Taken over the read value:<br><ul style="list-style-type: none"> <li>· For L1-L3 and L2-L3: At 50Hz: 0,8% · At 60Hz: 1,0%</li> <li>· For L1-L2: At 50Hz: 0,9% · At 60Hz: 1,1%</li> </ul>   |   |  |  |      |  |      |       |          |        |  |        |          |        |  |        |          |        |  |        |     |        |  |     |     |     |  |     |     |     |  |
| Frequency precision             | Taken over the read value: 0,3%  |   |  |  |      |  |      |       |          |        |  |        |          |        |  |        |          |        |  |        |     |        |  |     |     |     |  |     |     |     |  |
| Display of the reading value    | The value of the read magnitudes is displayed by means of the following status screen:<br><ul style="list-style-type: none"> <li>· VOLTAGE L1-L3: Voltage between L1 and L3</li> <li>· VOLTAGE L2-L3: Voltage between L2 and L3</li> <li>· VOLTAGE L1-L2: Voltage between L1 and L2</li> <li>· FREQUENCY: Frequency in the line</li> <li>· <math>\neq  Li-Lj </math>: Unbalance between phases</li> <li>· PHASE CYCLE: Phase sequence</li> </ul> |   |  |  |      |  |      |       |          |        |  |        |          |        |  |        |          |        |  |        |     |        |  |     |     |     |  |     |     |     |  |
| Output relay                    | From 1..3 independent relays, SPST NO. By default, we supply three relays.   |   |  |  |      |  |      |       |          |        |  |        |          |        |  |        |          |        |  |        |     |        |  |     |     |     |  |     |     |     |  |
| Output 4-20 mA                  | It is assigned to whichever of the measured magnitudes (voltage L1-L2, voltage L2-L3, voltage L1-L3, frequency, phases unbalance) to be transmitted through a 4-20 mA current loop, being able to coexist with the relays.<br>Precision: 1% additional to the read value.<br>This kind of output is optional.  |   |  |  |      |  |      |       |          |        |  |        |          |        |  |        |          |        |  |        |     |        |  |     |     |     |  |     |     |     |  |
| PC communication                | It is possible to establish different types of communication with a computer (see also last page):<br><ul style="list-style-type: none"> <li>- By telephonic connector that incorporates standard device and CPBZ programming interface.</li> <li>- By a RS232 connection (optional).</li> <li>- By a RS2485 connection and SBAZ converter (optional).</li> </ul>  |   |  |  |      |  |      |       |          |        |  |        |          |        |  |        |          |        |  |        |     |        |  |     |     |     |  |     |     |     |  |
| Supply voltage                  | [024] 24 VAC 50/60Hz<br>[110] 110..125 VAC 50/60Hz<br>[230] 220..240 VAC 50/60Hz<br>[400] 380..415 VAC 50/60Hz<br>[440] 440 VAC 50/60Hz<br>[903] 15..70 VAC/DC<br>[904] 60..240 VAC/DC   | Ranges<br>(VAC)   | <table border="1"> <thead> <tr> <th></th> <th>-18%</th> <th></th> <th>+18%</th> </tr> </thead> <tbody> <tr> <td>90,20</td> <td>110..125</td> <td>147,50</td> <td></td> </tr> <tr> <td>180,40</td> <td>220..240</td> <td>283,20</td> <td></td> </tr> <tr> <td>311,60</td> <td>380..415</td> <td>489,70</td> <td></td> </tr> <tr> <td>360,80</td> <td>440</td> <td>519,20</td> <td></td> </tr> <tr> <td>410</td> <td>500</td> <td>590</td> <td></td> </tr> <tr> <td>566</td> <td>690</td> <td>814</td> <td></td> </tr> </tbody> </table> |  | -18% |  | +18% | 90,20 | 110..125 | 147,50 |  | 180,40 | 220..240 | 283,20 |  | 311,60 | 380..415 | 489,70 |  | 360,80 | 440 | 519,20 |  | 410 | 500 | 590 |  | 566 | 690 | 814 |  |
|                                 | -18%   |   | +18%   |  |      |  |      |       |          |        |  |        |          |        |  |        |          |        |  |        |     |        |  |     |     |     |  |     |     |     |  |
| 90,20                           | 110..125   | 147,50  |  |  |      |  |      |       |          |        |  |        |          |        |  |        |          |        |  |        |     |        |  |     |     |     |  |     |     |     |  |
| 180,40                          | 220..240   | 283,20  |  |  |      |  |      |       |          |        |  |        |          |        |  |        |          |        |  |        |     |        |  |     |     |     |  |     |     |     |  |
| 311,60                          | 380..415   | 489,70  |  |  |      |  |      |       |          |        |  |        |          |        |  |        |          |        |  |        |     |        |  |     |     |     |  |     |     |     |  |
| 360,80                          | 440  | 519,20  |  |  |      |  |      |       |          |        |  |        |          |        |  |        |          |        |  |        |     |        |  |     |     |     |  |     |     |     |  |
| 410                             | 500  | 590   |  |  |      |  |      |       |          |        |  |        |          |        |  |        |          |        |  |        |     |        |  |     |     |     |  |     |     |     |  |
| 566                             | 690  | 814   |  |  |      |  |      |       |          |        |  |        |          |        |  |        |          |        |  |        |     |        |  |     |     |     |  |     |     |     |  |
|                                 | Warning  | Three-phase voltage must be disconnected before or simultaneously than the supply voltage, never later. |  |  |      |  |      |       |          |        |  |        |          |        |  |        |          |        |  |        |     |        |  |     |     |     |  |     |     |     |  |

Connection diagram

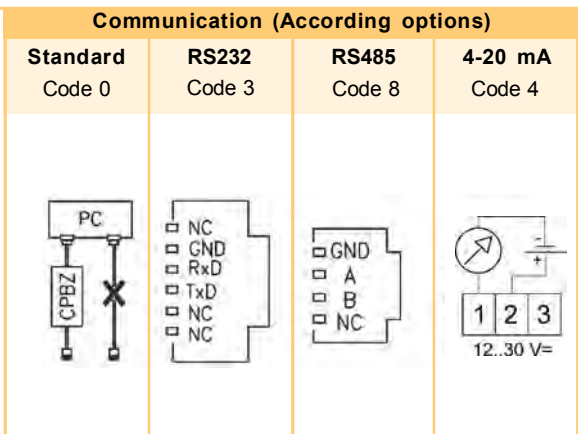
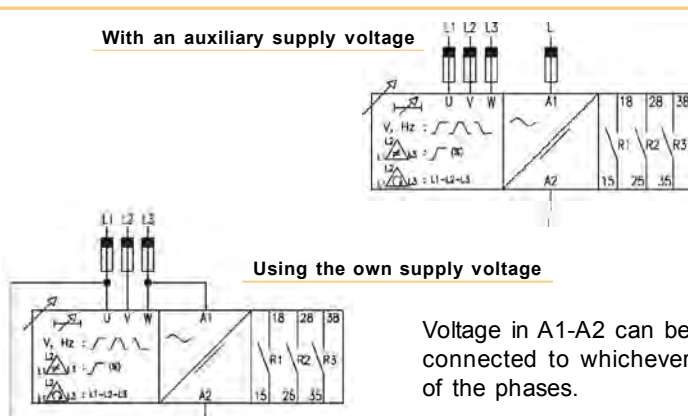

Phase sequence

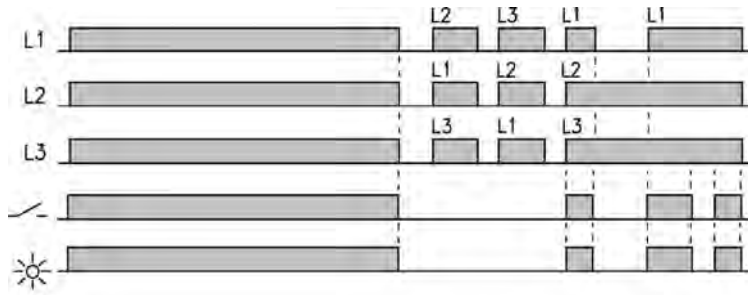

Control of the voltage among phases

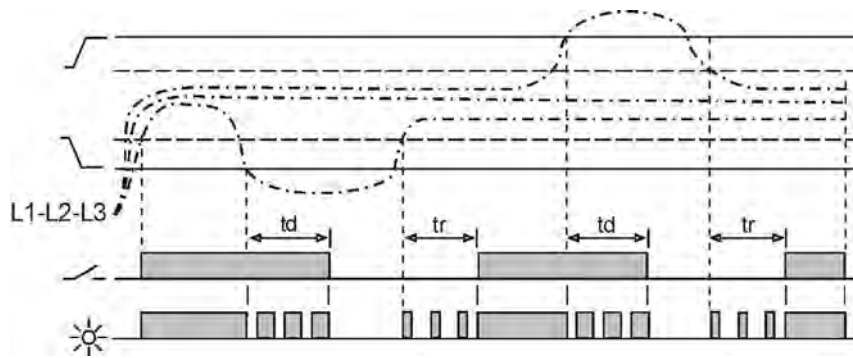

Frequency control

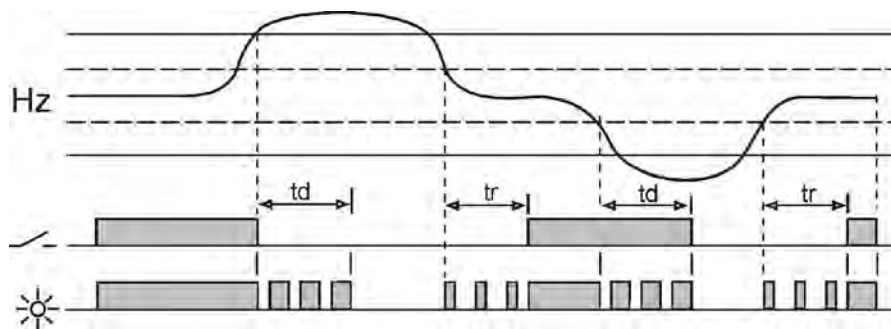

Unbalance among phases

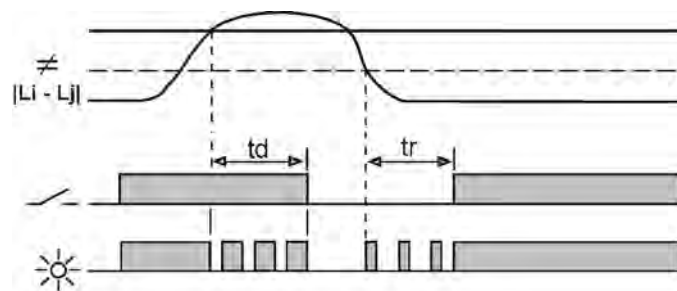

td = Delay on detection // tr = Delay on release



State of the relay may vary according to the application. What is shown in the diagrams belongs to the set-up of the default user's programmes 1 and 2.

|               |                            | SVO |                          |  |
|---------------|----------------------------|-----|--------------------------|--|
| Output relays | Resistive load             | AC  | 6 A / 240 V              |  |
|               |                            | DC  | 6 A / 24 V               |  |
|               | Inductive load             | AC  | 3 A / 240 V              |  |
|               |                            | DC  | 3 A / 24 V               |  |
|               | Mechanical life            |     | > 10 <sup>6</sup> oper.  |  |
|               | Max. mech. operations      |     | 18.000 operations / hour |  |
|               | Electric life at full load |     | 360 operations / hour    |  |
|               | Contact material           |     | AgSnO Alloy              |  |
|               | Operating voltage          |     | 240 VCA (85 °C)          |  |
|               | Voltage between contacts   |     | 1000 VAC                 |  |
|               | Voltage coil/contact       |     | 4000 VAC                 |  |
|               | Isolation resistance       |     | > 100 MΩ (500 VDC)       |  |
|               | Indication                 |     | 1 red led per relay      |  |

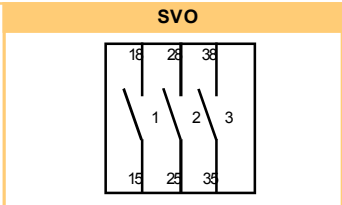

|                |                             | SVO  |          |  |        |  |
|----------------|-----------------------------|--|----------|--|--------|--|
| Supply voltage |                             | [024]..[440]                                   | [903]    | [904]                                      |        |  |
|                | Galvanic isolation          | 4000 V   | 2500 V   |  |        |  |
|                | Frequency                   | 50 Hz  | 60 Hz    | -  |        |  |
|                | Operating margins           | ±18%   | 15..70 V | 60..240 V                                  |        |  |
|                | Consumption                 | 2,5 VA   | 3,5 W    | 3,1 W                                      |        |  |
|                | Start-up time               | 120 ms   | 110 ms   | < 600 ms* < 200 ms*                        |        |  |
|                | Detection time              | 45 ms  | 40 ms    | 135 ms                                     | 130 ms |  |
|                | Reset                       | 1 net cycle and/or -30% of the nominal voltage |          | >70 ms* and/or -30% of the nominal voltage |        |  |
|                | Indication                  | Green led                                      |          |  |        |  |
|                | * In the worth of the cases |  |          |  |        |  |

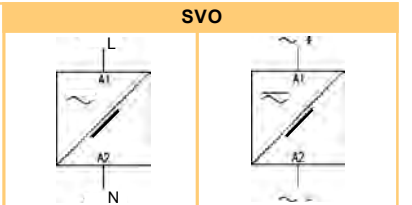

|                           |                      |
|---------------------------|----------------------|
| Voltage phase-neutral     | 300 V                |
| Overvoltage category      | III                  |
| Shock voltage             | 4 kV                 |
| Pollution degree          | 2 (EN61010)          |
| Protection                | IP 20                |
| Approx. weight            | 280 g                |
| Store temperature         | -30..+80°C           |
| Operating temperature     | -20..+50°C           |
| Humidity                  | < 95% HR             |
| Housing                   | Cyclooy - Light grey |
| Leds window               | Lexan - Transparente |
| Buttons, connector, clamp | Technyl - Dark blue  |
| Connector's terminals     | Brass                |
| Screws torque             | 0,8 Nm               |

Designed and manufactured under EEC normative.  
Directives referred:  
Electromagnetic compatibility: EMC 2004/108/EEC.  
Low voltage: LVD 2006/95/EEC.  
Hazardous substances: 2011/65/EEC  
Plastics: UL 91 V0

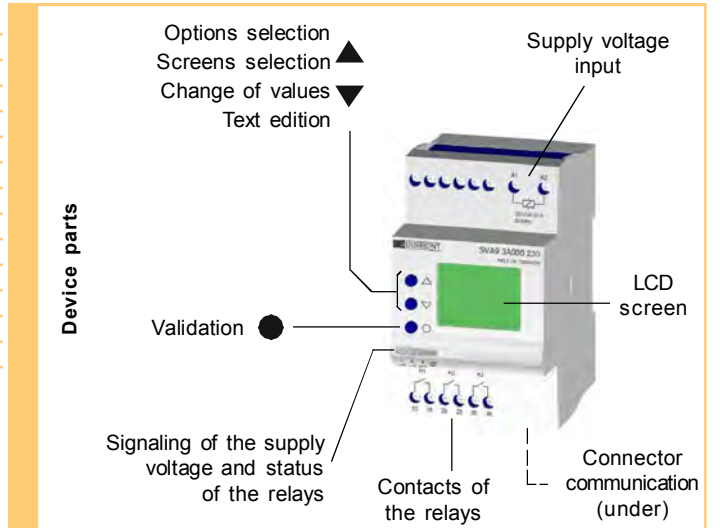

| Order code | Control - Interface  | Number of relays              | Type of relay                | Communication                                       | Version          | Supply   | Ranges  |
|------------|--|-------------------------------|------------------------------|---|------------------|--|---|
| <b>SVO</b> | With display.<br>Default languages:<br>· Spanish<br>· English<br>· French<br>· Catalan<br>(Other on request) | 0 - No relays<br>3 - 3 relays | 0 - No relays<br>A - SPST NO | 0 - No bus<br>4 - 4-20 mA<br>3 - RS232<br>8 - RS485 | 00..99           | [024] 24 VAC<br>[110] 110..125 VAC<br>[230] 220..240 VAC<br>[400] 380..415 VAC<br>[440] 440 VAC<br>[903] 15..70 VAC/DC<br>[904] 60..240 VAC/DC | [110] 110..125 VAC<br>[230] 220..240 VAC<br>[400] 380..415 VAC<br>[440] 440 VAC<br>[500] 500 VAC<br>[690] 690 VAC |
|            | Without display.<br>Without communic.  |                               |                              |   |                  |  |   |
|            | Without display.<br>Communication<br>RS232 / RS485.  | (By default, 3)               | (By default, A)              | (By default, 0)                                     | (By default, 00) |  |   |

To compose the reference, select one option of each column. Example: **SVO9 3A400 230 690**

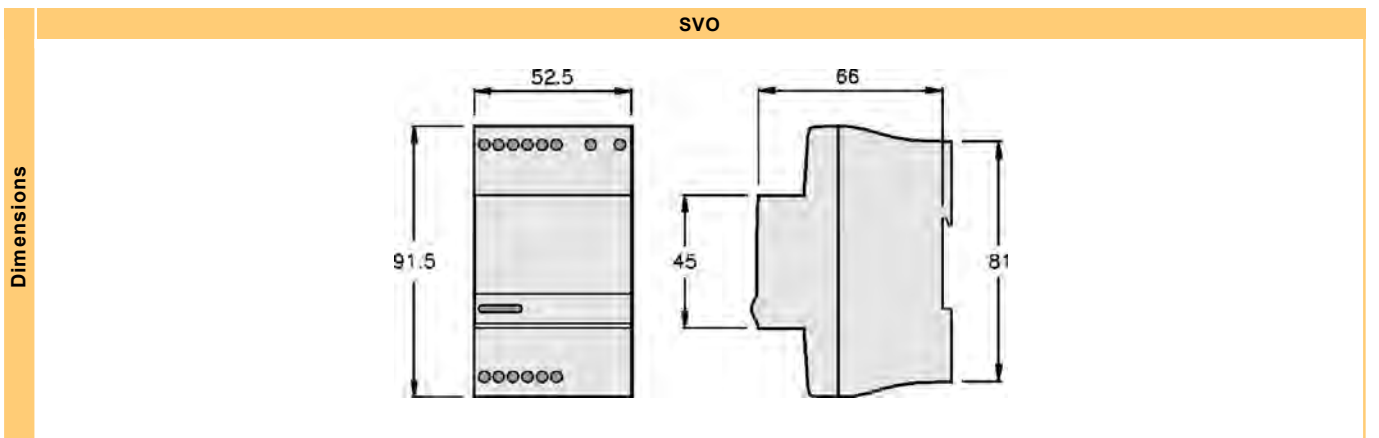

### GENERAL CHARACTERISTICS OF THE DIGITAL CONTROL RELAYS

|                   |   |
|-------------------|---|
| User's manual     | For a wide knowledgment of the options offered by the digital control relays, the own User's Manual for each model must be read. Although an issue is given with every purchased device, a copy can be downloaded in our web site ( <a href="http://www.disibeint.com">www.disibeint.com</a> ).   |
| How to programm   | The digital control relays can be indistinctly programmed either with the buttons placed in the front of the housing or with a personal computer.<br>Please refer at the end of this page to learn more about the PC programming alternative.   |
| Types of screens  | Status: They show the actual values of the magnitudes controlled by the relay.<br>User: Where the user can write a customized text to help to the relay identification.<br>Options: For accessing to the menus for the options selection.<br>Informatives for values: They show the information of the different set parameters.<br>Change of value: For modifying the values of the different values.<br>Screens menus: Group of screens related under the same concept and that can contain whichever type of the screens previously described. |
| Interactive menus | For an ease programming, into the menus only the options that can be set are the ones visible. The rest of the options are not visible. This feature is interactive, ie., it is produced automatically according whether other functions are activated or not.  |
| Changing values   | The screens for changing the values contain the margins between such value can be adjusted. These margins can depend of other options and this is because different margins could be displayed according to other previous relations.   |
| User's programm   | Provided by factory two programs with options and pre-configured settings for quick start-up team. In most cases, these parameters should be tweaked to suit the characteristics of each installation. The user can create your own program and store it on your computer.  |
| Display lighting  | The display remains backliighted while it is accessed to the different screens. If any button is not pressed for longer than 30 seconds, the light turns off.<br>In order to turn the light on, it is enough to press any button only once.   |
| Value added       | <ul style="list-style-type: none"> <li>- Four languages available in each relay</li> <li>- Graphic bar for the intuitive visualization of the displayed value</li> <li>- Historical control of the maximum values obtained by the relay</li> <li>- Screen's refresh selectable between 1 and 8 times per second</li> <li>- Possibility of locking the keyboard to avoid any undesired modification</li> <li>- Complementary timing functions</li> </ul>   |

### SPECIFIC CHARACTERISTICS FOR THE MODEL SVO

|                              |   |
|------------------------------|---|
| Alarm by frequency deviation | This option affects to those relays with any voltage parameter activated. By default, this option is activated. Inhibits the activation of the relay in the state of alarm when the requency is deviated in $\pm 0,4$ Hz during the detection process, and of $\pm 0,3$ Hz during the releas process.<br>For this kind of deviation in the frequency, the operating precision is reduced. More the frequency in the net is deviated, worse precision when reading its voltage.<br>If this option is deactivated, you must remember that the reading precision of the voltage parameters decrease when the frequency gets deviations from its nominal values (50 Hz / 60 Hz).<br>You must consider this reduction of precision when setting the values for detection and/or release. |
|------------------------------|---|

### PC COMMUNICATION

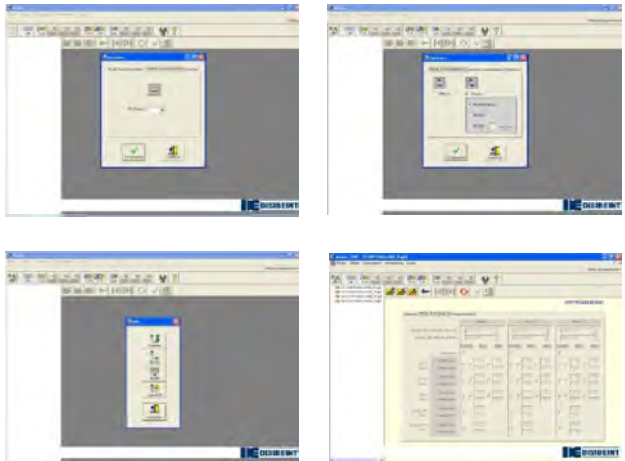
|       |   |  |
|-------|---|--|
| deCom | <ul style="list-style-type: none"> <li>· Communication and programming software for the digital control relays.</li> <li>· It allows the interactivity between the different types of communication: through the CBPZ interface, RS232 or RS485.</li> <li>· It displays the complete data related to the relay, gruoped by concepts and easing the intuitive programming.</li> <li>· It has control tools to do not exceed the operating margins of each model according to its range.</li> <li>· It is provided with templates to facilitate the programming of each model.</li> <li>· It allows to store the own settings.</li> </ul> <p>Windows XP minimum operative system (.NET Framework required).</p> |  |
|-------|---|--|



CURRENT LOOP 4-20 mA

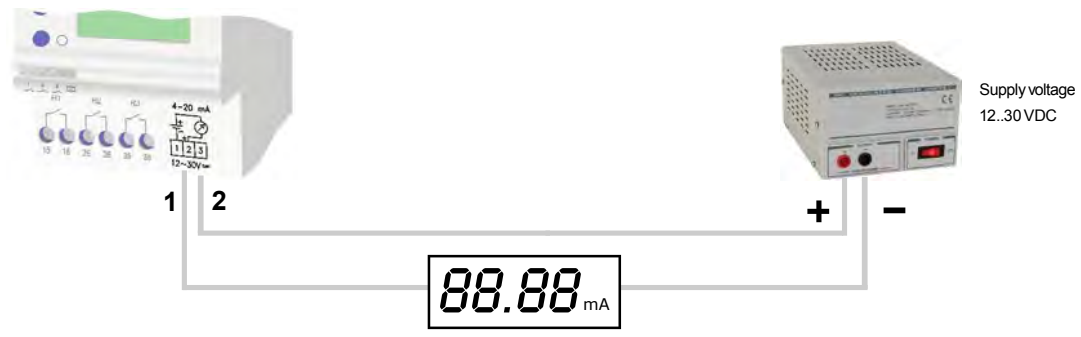

ACCESSORIES

**CBPZ**

Interface for remote programming from a PC.  
It allows the connection between whichever digital relay not provided with bus and a PC.  
Not required for devices provided with bus RS232, RS485 or with 4-20mA output.

**SBAZ**

RS485 to RS232 signal converter for the remote programming or for the data capture and visualization from a PC.  
It allows the connection of up to 31 digital control relays provided with RS485 communication bus, to get an unique codified RS232 output.

OUTPUTS COMMUNICATIONS

STANDARD MODE

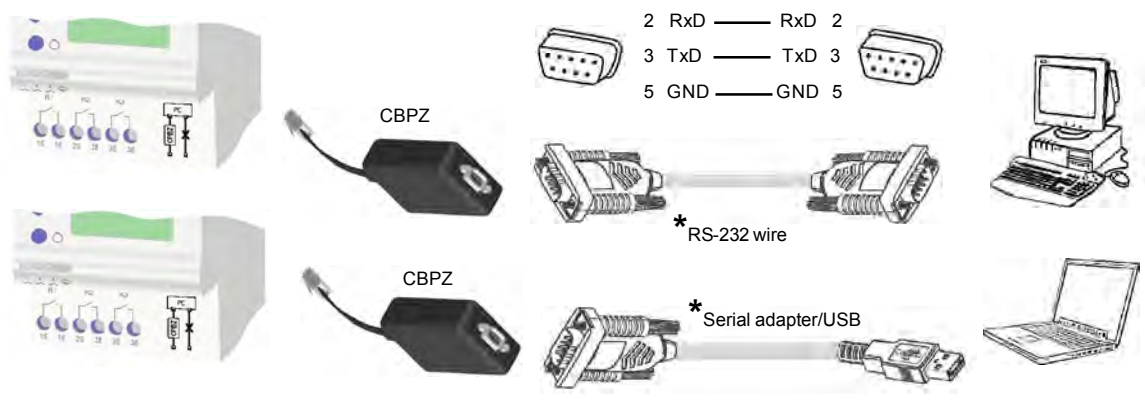

REMOTE PROGRAMMING

RS232 COMMUNICATION

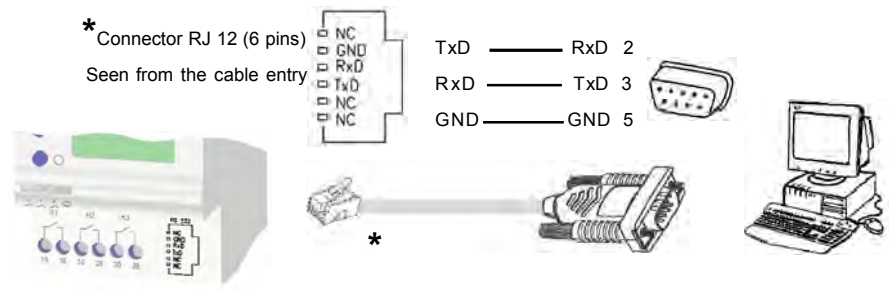

RS485 COMMUNICATION

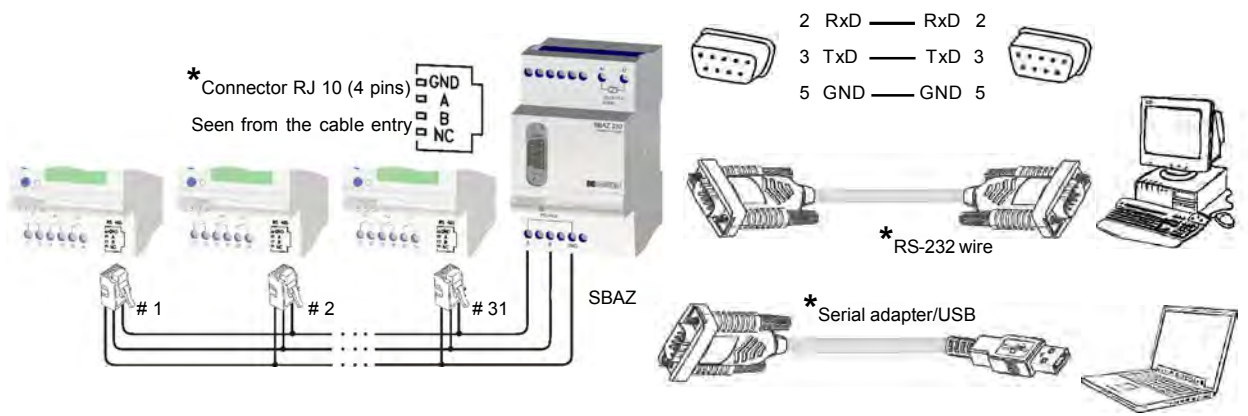

\* Disibeint not supply cables or connectors.  
You can find these products in stores specializing in computer equipment.

